

AKSİYAL FAN Ø450 (AKS-102-4ES-450)

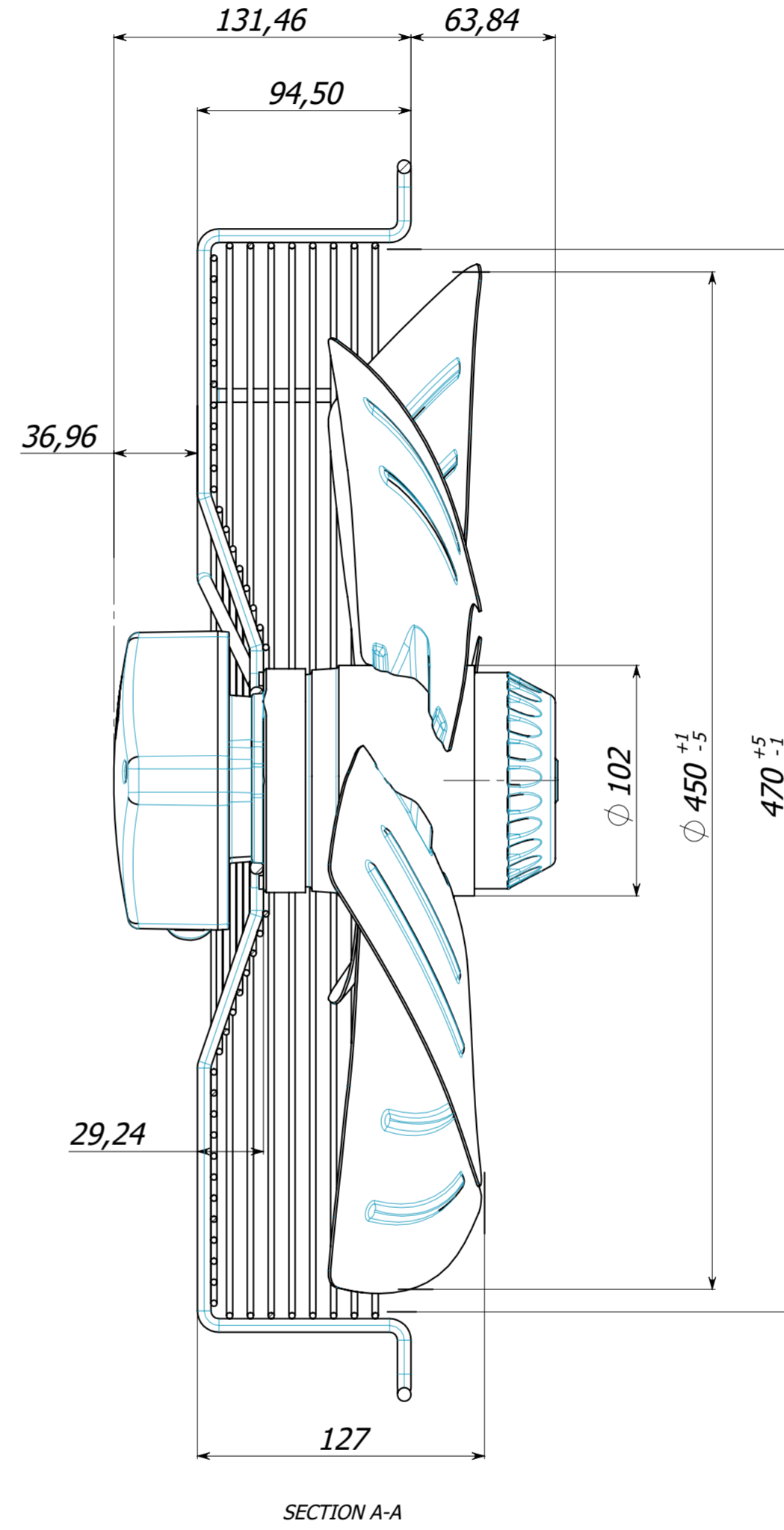
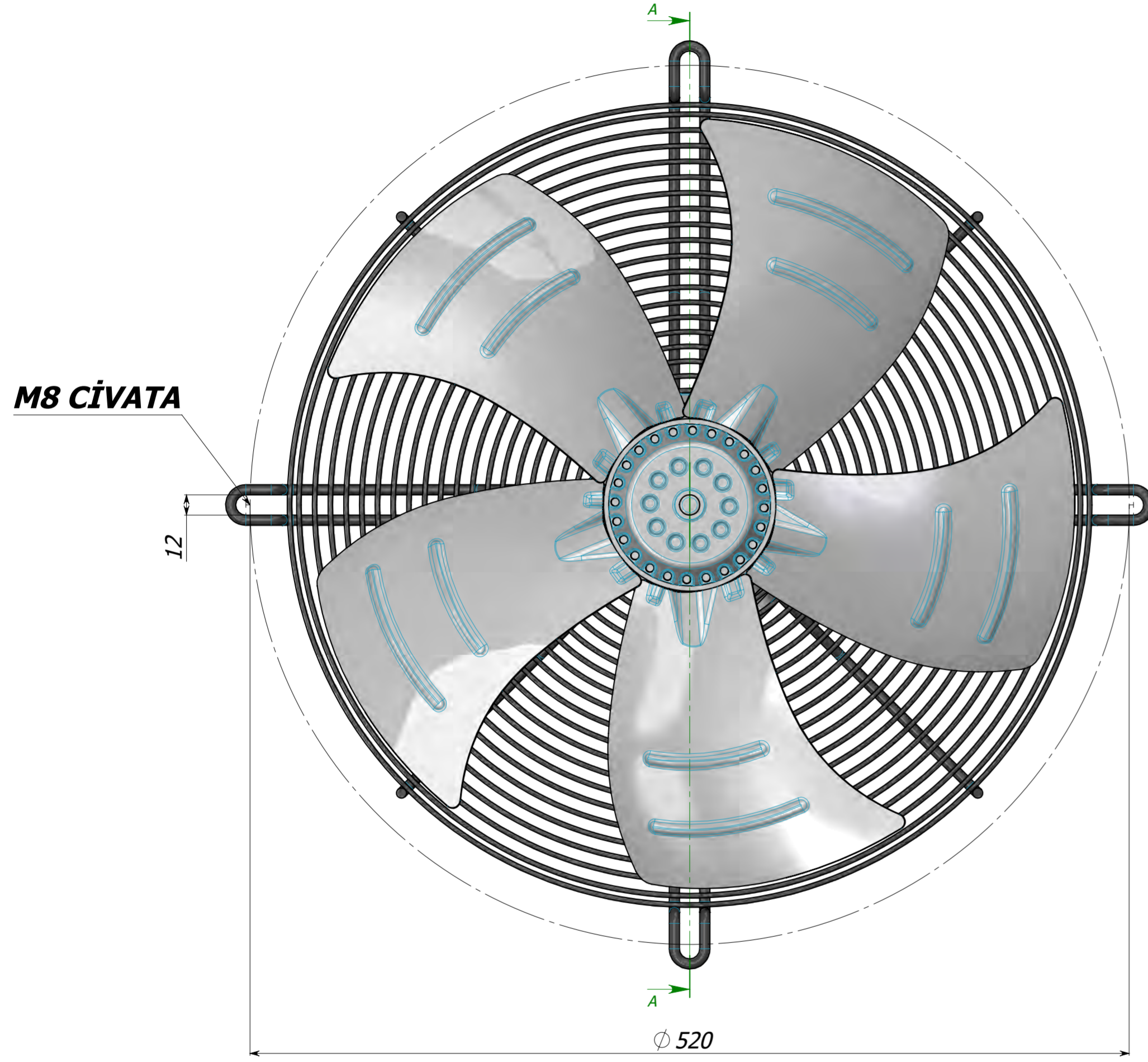

AKSİYEL FAN TEKNİK ÖZELLİKLER

	Voltaj [V]	Frekans [Hz]	Akım [A]	Giriş Gücü [W]	Devir [Rpm]	Debi [m3/saat]	Kapasitör [uF]	Ses Seviyesi [db(A)]	Net Ağırlık [Kg]
AKS-102-4ES-450	230	50	1,25	270	1350	5000	10	67	7,2

DİĞER ORTAK ÖZELLİKLER

Yalıtım Sınıfı	F
Koruma Sınıfı	IP54
Isı Koruma	Termik Koruma
Ortam Sıcaklığı	-30C ~ +60C
Sertifika	CE
Enerji Verimliliği	ErP2015

Ölçek 1:2.5	Malzeme: Boya:	Kaplama:	Net Ebatlar (mm)	Adet	Net Ağırlık (gr)	Sertlik							
Onay:	Kadir ERDEM		AKSİYAL FAN Ø450		Kod no:	AKSİYAL 450							
Kontrol:	Mehmet SIRAÇ				Resim no:	-							
Çizen:	Mehmet SIRAÇ				İlk yayın:	6.10.2020							
	İsim	İmza			Sayfa no:	1/1							
Genel Tolerans:	DIN 7168	0.5-6	6-30	30-120	120-400	400-1000	>1000	Açısal Tolerans:	< 10°	> 10°	± 0.5°	± 1°	⊕